

# SANYO

## SUMMARY MANUAL

## VCC-HD4600 VCC-HD4600P

### Megapixel Camera

**THIS INSTALLATION SHOULD BE MADE BY A QUALIFIED SERVICE PERSON AND SHOULD CONFORM TO ALL LOCAL CODES.**



**Please read this instruction manual carefully in order to ensure correct installation. In addition, be sure to read carefully the electronic manual (INSTRUCTION MANUAL) contained in the supplied CD-ROM to ensure correct operation of the camera.**

English

Français

Español

Deutsch

中文简体

日本語

# Contents

---

Name and Function of Each Component .....	2
Basic Connections .....	6
Network Settings .....	9
Specifications .....	11
Copyright Notice .....	13

## ■ Accessories

- ① Power supply connector    ② CD-ROM



---

## ■ Check your operating environment.

To operate the camera via network operation, you must meet the following operating requirements.

- **PC** : IBM PC/AT compatible
- **Operating system** : Windows XP Professional/Windows Vista
- **CPU** : Core2Duo E6700 2.66 GHz or higher
- **Memory** : Windows XP: 1GB or more  
Windows Vista: 2GB or more
- **Network interface** : 10Base-T/100Base-TX (RJ-45 connector)
- **Display card** : 1920×1200 pixels or higher
- **Graphics chip** : ATI RADEON HD2600 series or higher  
nVIDIA GeForce 8600 series or higher  
nVIDIA Quadro FX550 series or higher
- **Web browser** : Internet Explorer Ver. 6.0 SP2 or higher,  
or Internet Explorer Ver. 7.0

---

## ■ You can automatically set up the IP address of the camera.

This software application is useful when two or more cameras are connected to the network.

Download "Auto IP Setup" software application from the supplied CD-ROM.

# Name and Function of Each Component

## ■ Rear Face

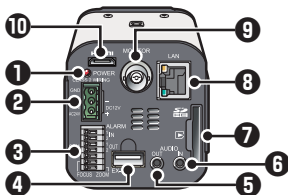

### 1 Power Indicator (POWER)

This indicator lights up when the camera is powered on.



**When the camera is on, this indicator blinks to indicate the following camera statuses:**

- Firmware update in progress
- Deactivation of media recording is in progress.
- Error occurring on SD memory card or external hard disk drive (faster blink)

### 2 24 VAC/ 12 VDC Power Connector Terminal

Connect a 24 VAC or 12 VDC power supply to this terminal using the supplied Power supply connector.

For details, refer to the “Basic Connections” (📖 Page 6) section.

### 3 Control Terminals (7 push-lock pins)

For details, refer to the “Control Terminal Connections” (📖 Page 7) section.

### 4 External hard disk terminal (EX-HDD)

To record live video on a hard disk, put the hard disk in a dedicated hard disk case (VA-HDC4000), sold separately) and then connect the case to the camera.

For details, refer to “Installing and formatting recording media” section on the electronic manual.

### 5 Audio Output Jack (AUDIO OUT, 3.5-mm mini jack)

Connect this jack via an audio cable to the audio input jack of an amplified speaker system or the monitor.

### 6 Audio Input Jack (AUDIO IN, 3.5-mm mini jack)

Use this jack to connect an external microphone to listen to the sound while monitoring the live video, or simultaneously record the video and sound.



**This jack supports 3.5-mm diameter monaural microphone plugs, or monaural line-level input plugs (the left channel only for stereo plugs).**

## Name and Function of Each Component

### 7 SD (SDHC) Card Slot

When recording live video onto an SD memory card, insert the card into the slot. For details, refer to “Installing and formatting recording media” section on the electronic manual.

### 8 LAN Connector (RJ-45)

Use this socket to connect the camera to your PC to enable network operation. For details, refer to the “Basic Connections” (📖 Page 6) section.



- **Link access indicator (Green):**

This indicator lights up approx. 3 seconds after power on, if a connection has been established between the camera and the network. After that, it will blink when data are being transmitted via the network.

- **Speed indicator (Orange):**

The camera automatically detects the local network transmission speed (10BASE-T or 100BASE-TX).

This indicator lights up when 100BASE-TX data transmission is in progress; it goes out when 10BASE-T data transmission is in progress.

### 9 Monitor output terminal for video adjustment

Connect this terminal to a monitor, etc. A live video will be displayed on the monitor once the camera is turned on. For details, refer to the “Basic Connections” (📖 Page 6) section.

While displaying live video, the current zoom magnification is displayed on the screen.

#### <Zoom magnification display>

- Optical zoom area:  $\times 1.0$  to  $\times 10.0$

- Electronic zoom area:  $\times 11$  to  $\times 160$

Zoom magnification settings (ex. enabling/disabling the magnification display, displaying position) can be configured via network operation on the VIDEO & AUDIO SETTINGS (TV OUT) screen.



### 10 HD video output terminal (HDMI)

The terminal outputs super-fine HD (High Definition) video signal. Use the terminal to connect a high-definition monitor with HDMI interface.

For details, refer to the “Basic Connections” (📖 Page 6) section.

## ■ Side Face

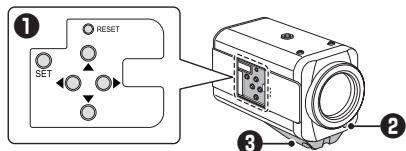



### 1 Operation Buttons

When using operation buttons on the camera, slide and open the side cover to access the buttons.



**Some operations can be performed via network operation.**

#### A Basic operations (focus adjustment, zoom, etc.)

- Adjusting focus: Press the ▲ button to set the focus to a near target; press the ▼ button to set the focus to a far target.  
 Live screen control panel
- Zoom: Press the ◀ button to zoom out of the image; press the ▶ button to zoom into the image.  
 Live screen control panel

#### B Menu screen operations



Press the SET button for 2 seconds or more to display the menu screen. For details, refer to the “Using the Menu screen” on the electronic manual.

- Moving the cursor up or down: Press ▲ button to move the cursor upward, or press ▼ button to move the cursor downward.
- Selecting the setting value: Press ◀ or ▶ button to change the setting value.
- Set the selected value: Press the SET button.



#### C Miscellaneous operations (ex. restarting the camera)



**Never press the RESET button while recording is in progress. The video may not be recorded properly.**

- Restarting camera: Press the RESET button.**  
 OPTION SETTINGS (CAMERA REBOOT)
- Restoring factory default settings: Press the ▲ and ▼ buttons simultaneously.**  
 OPTION SETTINGS (FACTORY DEFAULT)
- Stopping recording/Removing the recording medium: Press the ▲ and SET buttons simultaneously.**  
 ⇨ The power indicator starts blinking and then stay lit when the camera is ready for you to remove the recording media.  
 SD/HDD SETTINGS

## Name and Function of Each Component

- **Resuming recording/Recognizing the recording medium: Press the ▼ and SET buttons simultaneously.**
  - ⇒ The power indicator starts blinking and then stay lit after the camera recognizes the recording medium and is ready for recording.
  -  SD/HDD SETTINGS
- **Resetting the login password (for default users only): Press the ◀ and ▶ buttons simultaneously.**
  -  Not supported via network operation

### 2 Power indicator

The indicator also works as an error indicator.

**Power indicator:** The indicator lights up when the camera is powered on.

**Error indicator:** The indicator blinks when an error occurs.

- ! **To activate the power or error indicator, via network operation on the OPTION SETTINGS screen, change the setting for [POWER LED (FRONT)] or [ERROR LED (FRONT)] respectively.**

### 3 Bracket

This bracket may be attached to either the top or bottom face of the camera depending on the installation environment.

For bracket installation, be sure to use the longer screws supplied.

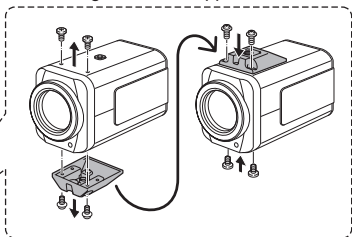
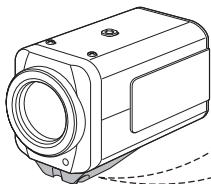

- ! **Install the camera securely to a durable location, taking into account the total weight of the camera mount (commercially available) and the camera.**

## Basic Connections

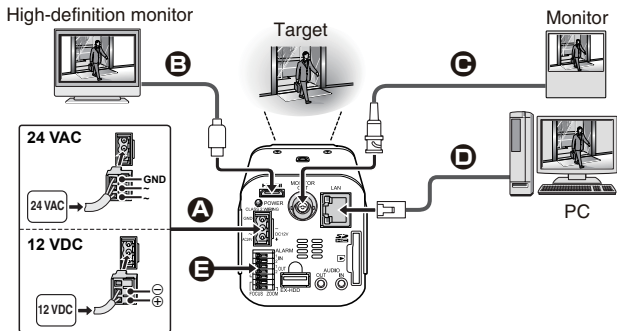

### A Power Connection

Attach the supplied power connector into the power terminal. Loosen the screws on the side face of the connector, connect the power cables to it, and tighten the screws. Connection method depends on the power supply (24 VAC or 12 VDC).

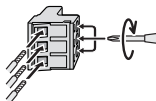

#### Connection to 24 VAC power supply:

Although the power terminals have no polarity, the earth grounding wire must be connected to the COM (GND) terminal.

#### Connection to 12 VDC power supply:

Note the polarity (+/-) of the power terminals when connecting the camera to a 12 VDC power supply.

Incorrect polarity may cause damage to the camera.



- To prevent a fire hazard use any UL listed wire rated VW-1. Be sure to use an 18AWG or thicker wire power cable.
- If you must use a long power cable, determine the cable type by ensuring that the voltage at the 24 VAC/12 VDC terminal is within the operating range of the camera.

When the camera is powered on, the POWER indicator lights up and the live video is displayed on the connected monitor.

## Basic Connections

---

### **E** High-Definition Monitor Connection

Connect the HDMI cable to the HD video output terminal (HDMI).



**You cannot output the video simultaneously from HD video output terminal (HDMI) and from monitor output terminal (MONITOR OUT). When both terminals are used, the HD video output terminal takes precedence.**

### **C** Monitor connection for video adjustment

Connect the coaxial cable to the SD video output terminal (MONITOR OUT).

### **D** Network Connection

This camera is designed so that you can use all of its functions via network operation.

By connecting the network (LAN) socket of the camera to your PC using a LAN cable, you can configure and operate it from the Web browser installed on your PC.



- Use a LAN cable no longer than 100 m (109.4 yards) with the shield type CAT5 or higher.
- The supported Web browser is Internet Explorer Ver.6.0 SP2 or higher, or Internet Explorer Ver.7.0.
- Configure the network information using the camera's menu item [NETWORK SET].  
For details, refer to "Configuring the network settings of the camera" section on the electronic manual.
- The same settings can be performed via network operation on the NETWORK SETTINGS screen.

### **E** Control Terminal Connections

#### **A** Alarm output terminals (ALARM OUT1/2)

Connect a buzzer, lamp, or other alarm device to one of the alarm output terminals.



- After connecting an alarm device, configure the output conditions for the corresponding alarm output terminal (ALARM OUT1 or 2) via network operation on the ALARM SETTINGS screen.
- Alarm output terminal configuration is also possible via remote operation.

#### **B** Alarm input or Day/Night switching terminals (ALARM IN1/2)

These input terminals can be used for either of the following purposes:

##### • Alarm input

Connecting an external switch, infrared sensor, or other device to these terminals enables the camera to detect alarm conditions such as the entry of an intruder.



- After connecting an alarm device, configure the input conditions for the corresponding alarm input terminal (ALARM IN1 or 2) via network operation on the ALARM SETTINGS screen.



### • Day/Night switching

Normally, switching the camera between the color and black-and-white video modes is automatically accomplished by the Day/Night function.

Using one of these alarm input terminals as the Day/Night switching terminal, however, enables the camera to be switched between the color and black-and-white video modes when an external control signal is received.



- To use the alarm input terminals as Day/Night switching terminals, follow the steps below.
  - Under [DAY/NIGHT], set [DAY/NIGHT] to “COLOR” and select the terminal you want to use in [EXT ALARM].
  - On the ALARM SETTINGS screen, in [POLARITY], select the signal polarity of the alarm input terminal.

### Ⓒ Zoom/Focus adjustment terminal (ZOOM/FOCUS)

Zoom and focus adjustment operations can be performed remotely by external voltage control.

## ■ Connection Diagram (Thicker than 24 AWG, 600 m / 656 yds. max.)

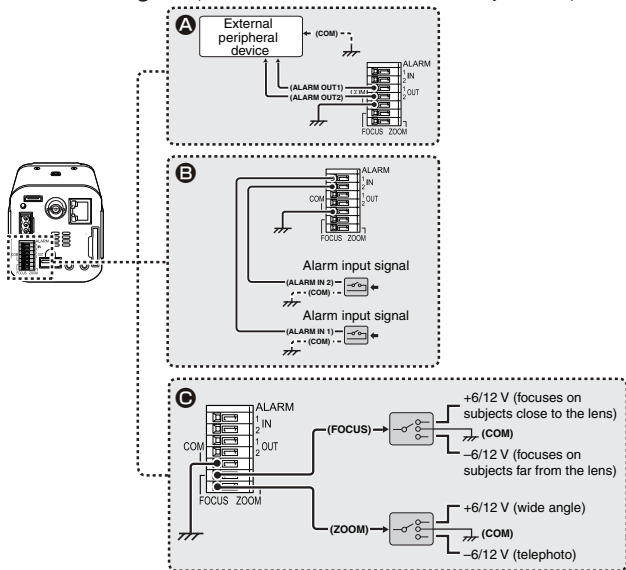

# Network Settings

---

## Preparing Your Computer for Network Operation

- 1 Check your operating environment.** (  Page 1)
- 2 Connect the camera to the network to which your PC is also connected.**
- 3 Configure the network information on your PC.**  
Configure information such as the IP address of your PC.
- 4 Install the “H.264 Plug-in” from the supplied CD-ROM onto your PC.**  
You are now ready to monitor the surveillance video in the H.264 format.
- 5 Start Internet Explorer.**  
The supported Web browser is Internet Explorer Ver.6.0 SP2 or higher, or Internet Explorer Ver.7.0.
- 6 Access the camera from your Web browser.**  
From your Web browser (Internet Explorer), access the camera and log into the system as an “admin” user (administrator).
- 7 In the address bar, type the IP address of the camera and press [Enter] key.**  
When you access the camera, the login screen appears.  
If this is the first access to the camera, in the Address bar, enter the default IP address as follows.

Address



**If you set [SSL] to “ON”, before the IP address, type “https://” (instead of “http://”).**

**Attempts to access the camera using the default IP address will fail if that address is already being used by another device in the network. If so, change the IP address of the existing device before accessing the camera.**

- 8** Type your user name and password and click [OK].  
The language selection screen appears.

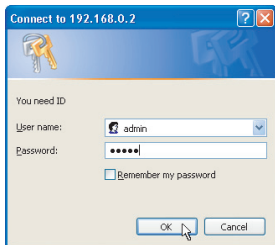

**If this is the first access to the camera, log in as an admin user (administrator) using the following default authentication information.**

- **User name: admin**
- **Password: admin**

- 9** Click the button corresponding to the language you want to use.  
The live screen appears.

From the second login onwards, the live screen appears automatically by skipping the language selection screen.

If this is the first access to the camera, configure the system clock on the CLOCK SETTINGS screen.

# Specifications

## ■ Camera

<b>Image pickup device</b>	1/2.5" CMOS sensor
<b>Effective pixels</b>	16:9 1920 (H) × 1080 (V), 4:3 2288 (H) × 1712 (V)
<b>Lowest image illumination</b>	50IRE: 2.0 lx (F1.8, in color mode with high gain) 50IRE: 0.1 lx (F1.8 in black-and-white mode with high gain)
<b>Video S/N ratio</b>	50 dB or higher (when AGC is "Off")
<b>Lens</b>	Focal Length: 6.3 to 63 mm, F number: F1.8 - 2.5 Optical zoom 10x, electronic zoom 16x (up to 160x when used in combination with the optical zoom)
<b>Digital PTZ</b>	Enables electronic pan, tilt, and zoom operations on clipped subject areas in VGA size, Zoom magnification: 2x max
<b>DNR (digital noise reduction)</b>	ON/OFF
<b>Image inversion</b>	Horizontal/Vertical/Horizontal and vertical/Off
<b>Privacy mask</b>	On/Off, max. 8 mask patterns
<b>Motion sensor</b>	On (Motion masking/motion detection area setting, or video analytics)/Off, face detection
<b>Sway compensation</b>	ON/OFF
<b>Language selection</b>	English, French, German, Spanish, Japanese

For further details on the specifications of the camera, refer to the electronic manual.

## ■ I/O

<b>Video output</b>	HD Output: HDMI terminal (TYPE C) Monitor output for video adjustment: BNC terminal (MONITOR OUT)
<b>LAN</b>	10BASE-T/100BASE-TX (RJ-45 connector)
<b>EX-HDD Connector</b>	For connecting SANYO-specified external hard disk case (VA-HDC4000)
<b>SD Card Slot</b>	1 (SDHC compliant, max. 32 GB supported)
<b>Alarm input</b>	2 (NO/NC), also serving as Day/Night switching function input <control terminals>
<b>Alarm output</b>	2 (NO/NC switching, 16 V, 150 mA, open collector) <control terminal>
<b>Lens remote control</b>	Zoom, Focus, Common (Voltage control: ±(6 to 12 V)) <control terminal>
<b>Audio input/output</b>	Audio input (3.5-mm Mini jack) <AUDIO IN> Audio output (3.5-mm Mini jack) <AUDIO OUT>

## ■ Recording media

<b>SD memory card/ External HDD</b>	Normal recording, Alarm recording, Backup recording in event of a network failure, Log information recording
---	--

For the recommended SD memory cards, visit our website.

<http://www.sanyo-cctv.net/>

## ■ Network

Image/video compression	H.264/JPEG
Video size (H.264)	(16:9) 1920×1080, 1280×720, 640×360, 320×180 (4:3) 1600×1200, 1280×960, 1024×768, 640×480, 320×240
Video size (JPEG)	(16:9) 1920×1080, 1280×720, 1024×576, 640×360 (4:3) 2288×1712, 1600×1200, 1280×960, 1024×768, 800×600, 640×480, 320×240
Picture quality	QUALITY mode: BASIC, NORMAL, ENHANCED, FINE, SUPER FINE BITRATE mode: User-specified bit rate
Interface	10BASE-T/100BASE-TX
Protocol	TCP/IP, UDP, HTTP, HTTPS, SMTP, NTP, DHCP, FTP, DDNS, RTP, RTSP, RTCP
Audio	G.711 (Bidirectional)
Simultaneous access	20
Security	BASIC authentication (ID/password), SSL, IP filtering

## ■ Others

Operating ambient temperature/humidity	-10 to +50°C, 14 to 122°F 90% RH or less (no condensation)
Power source	<ul style="list-style-type: none"> <li>• 12 to 15 VDC</li> <li>• 24 VAC±10%, 50/60 Hz</li> <li>• PoE</li> </ul>
Power consumption	15 W (PoE: 12.3 W)
Weight	420 g/14.8 oz.

## ■ Dimensions

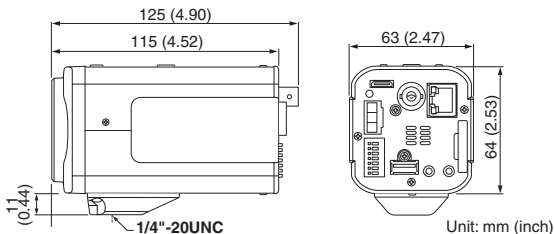

Appearance and specifications are subject to change without prior notice or obligations.

## Copyright Notice

---

The instruction manual and the software are copyrighted by SANYO Electric Co., Ltd. No materials contained in the manual and the software may, wholly or partially, be copied, modified, reproduced, or distributed in any format without the prior permission of the copyright holder.

Microsoft, Windows, ActiveX and Internet Explorer are registered trademarks or trademarks of Microsoft Corporation in the United States and other countries. The official name for “Windows” used in this manual is Microsoft® Windows® Operating System.

In this manual, note that the word “Windows” refers to both “Microsoft® Windows® XP Operating System” and “Microsoft® Windows® Vista Operating System”.

Intel and Pentium are registered trademarks or trademarks of Intel Corporation and its subsidiaries in the United States and other countries.

IBM and IBM PC/AT are trademarks of International Business Machines Corporation. All other brands and product names in this manual are the registered trademarks or trademarks of their respective owners.

SDHC Logo is a trademark.



### ■ Notes on data storage

- It is recommended that important data be copied to a separate medium.
- In the following situations, it is possible that recorded data may be lost (destroyed). Our company bears absolutely no responsibility for damages or profits loss due to the loss of data.
  - The medium (SD card or external hard disk) is not used correctly.
  - The medium is not installed on the device correctly.
  - The medium is subjected to electrical or mechanical shock.
  - The card is removed or the power is turned off while the card is being accessed.
  - The medium has reached the end of its service life.

### ■ License for Software Contained in CD-ROM

- Please read carefully the terms and conditions contained in the license agreement that appears on the screen during the software installation process. Provided that you have agreed to all the terms and conditions therein, you may use the software subject to the license agreement.
- For information on the other products or services provided by third parties which are introduced in the CD-ROM, please contact each supplier or manufacturer.

1AC6P1P4038--  
L5DH2/XE, US, JP (1009KR)

**SANYO**

**SANYO Electric Co., Ltd.**